

CVS V-100 Ball Valves 2 through 8 Inch Designs.

Introduction:

These instructions apply specifically to the 2 through 8 inch CVS V-100 Ball Valve Bodies. This manual provides maintenance, operation, installation, and parts ordering information. The valve bodies are normally equipped with actuators and accessories. Please refer to the appropriate instruction manuals.

The CVS V-100 ball valve design utilizes a standard ball with a triangular shaped wedge formed in it. This design allows for both throttling control and on/off service used in conjunction with a variety of actuators.

The CVS V-100 valve design closes against one of several available ball seals with a shearing action. The CVS V-100 is a flangeless design and allows the valve body to fit between two existing pipeline flanges. The flow characteristic is modified equal percent, with normal (forward) flow into the convex side of the V-ball.

Bi-directional flow is into either side of the V-Ball; TCM ball seal, metal ball seal, or flow ring.

Typical actuators used; are the pneumatic spring and diaphragm rotary actuator (CVS 1051), and the pneumatic piston rotary actuator (CVS 1061). Mounting of these actuators can be on the right-hand or left-hand side viewed from the forward flow inlet.

Refer to page 2 for additional specifications.

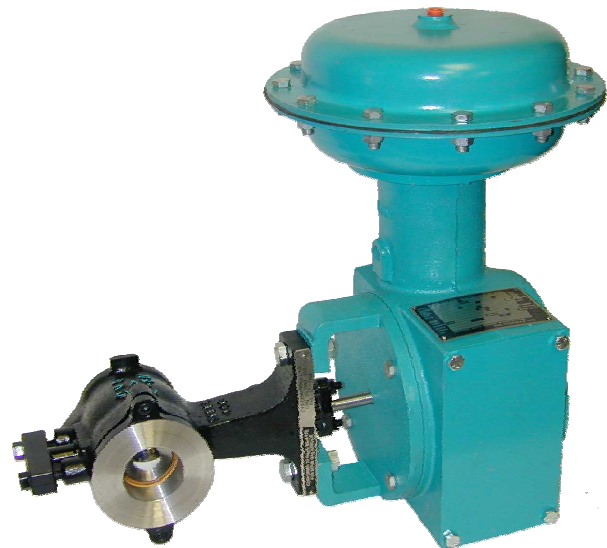

*Design CVS V-100 Valve Body Shown
with CVS Type 1051 Actuator*

Installation:

The valve body and internal components are made of specific materials, and are designed for specific temperature, fluid control, pressure, and pressure drop conditions. The following listed parts may compromise the valve if temperature ranges and service drops have been exceeded; Body, bushings, shaft, and ball seals.

Operation of these valves outside the specified application ranges may cause damage to equipment and or personal injury.

These valves **must not be used** outside the specified condition ranges without contacting your CVS sales representative.

CVS recommends the installation of pressure control or pressure relieving devices.

Specifications

End Connection Style	Flangeless body fits between RF Flanges, retained by line bolts. See Table 2 for body/flange compatibility.	
Maximum Inlet Pressures, Temperatures and Pressure Drops¹	Consistent with ANSI Class 150, 300 and 600 lb pressure/temperature ratings as per ANSI B16.34 Refer to Table 2 and do not exceed the pressure, pressure drop and temperature conditions specified at the time of ordering. Refer to "Installation"	
Flow Characteristic	Modified Equal Percentage	
Flow Direction (See Figure 2)	Forward flow (normal) is into the convex side of the ball. Flow ring construction and all ball seals are suitable for forward flow.	
Range Ability	300:1	
Shutoff Classification	Metal Ball Seal	0.001% of valve capacity at full travel: 1/10 of Class IV per ANSI/FCI 70-2
	TCM Ball Seal	2 ml of air/min/inch of nominal valve size at 50 psi differential (3.4 bar, differential)
	Flow Ring	2% of valve capacity at full travel
Maximum Valve Rotation	90 degrees	
Mounting of Actuator	Right-hand or Left-hand as viewed from valve inlet	
Approximate Weight	See Table 3	
Additional Specifications	See "Parts List" section of this manual for packing instructions and material specifications	
1. Pressure, pressure drops and temperature limits in this manual as well as any applicable standard or code limitation must not be exceeded.		

Table 1, Approximate Weight

Body Size, Inches.	Weight	
	Lbs.	Kg
2	21	9.5
3	35	15.9
4	55	25
6	85	38.5
8	135	61.2

Table 2, Body Rating and Flange Compatibility

BODY SIZE, INCHES	ANSI RATING CLASS COMPATIBILITY (B16.34-1996)	FLANGE COMPATIBILITY	
		ANSI CLASS	DIN PN
2	150, 300, 600	150, 300, 600	10, 16, 25, and 40
3 Through 6	150, 300, 600	150, 300, 600	10, 16, 25, and 40
8	150, 300, 600	150, 300, 600	10, 16a, 25a, and 40a
a. Special construction required.			

Table 3, Approximate number of 0.005" (0.13 mm) Shim Seals required to determine Zero Deflection

BODY SIZE, INCHES	BALL SEAL			FLOW RING
	METAL	Bi-Directional	TCM	
2	13	10	6	9
3	13	10	7	9
4	13	10	9	9
6, and 8	13	10	11	9

Table 4, Number of 0.005 (0.13 mm) thick Shim Seals to Remove after Determining Zero Deflection

BODY SIZE, INCHES	BALL SEAL		
	METAL	Bi-Directional	TCM
2	4	3	1
3	4	4	2
4	4	4	4
6, and 8	4	4	6

Table 5, Min. Clearance for Flow Ring Construction

SERVICE TEMPERATURE		FORWARD FLOW		REVERSE FLOW	
°F	°C	In.	mm	In.	mm
To 405	To 207	0.015	0.38	0.030	0.76
Above 405	Above 207	0.025	0.64	0.040	1.02

Table 6, Recommended Bolt Torque

KEY NUMBER	BODY SIZE, INCHES	BOLT TORQUE	
		ft•lb.	N•m
Guide Post Retainer Nut Key 6	2	10	14
	3	18	24
	4	21	28
	6	35	47
	8	60	81
Cap Screw Key 11	2-6	65	88
	8	100	136

Installation Cont.:

Inspect the valves for shipping damage and foreign debris when uncrating.

CVS recommends the installation of a standard three-valve maintenance by-pass system. This allows for isolation of the valve body without shutting down the pipeline.

1. Ensure the pipeline is free of welding slag, and foreign debris by blowing out the pipe lines before installation.
2. When mounting between pipeline flanges, ensure the two connecting flanges are in line. Install approved gaskets between the valve body and the pipeline flanges.
3. Position the valve on the line so that the flow direction indicator corresponds to the direction of the flow of the pipeline. If the valve body is being used in a bi-directional flow application then the flow direction indicator should correspond to the direction of the highest flow condition.
4. When installing flange bolts, use figure No 4 to obtain necessary clearances.
5. Tighten the bolts in a crisscross pattern to ensure all bolts are evenly torqued.
6. Install the CVS V-100 ball valve horizontally in the pipeline with the ball valve closing downward. The actuator can be installed in a number of positions; refer to figure 3 and the actuator instruction manual.

Installation Cont.:

7. When a manual actuator is used in combination with a power actuator, it will be necessary to install a bypass valve on the power actuator. This will allow the operation of the manual actuator. Following the power actuator instruction, connect the pressure line to the actuator.

Note: Grounding the valve shaft is required when the valve is exposed to hazardous goods or installed for oxygen use. Without grounding the valve shaft, an explosive situation may result from the static electricity from the valve parts.

Maintenance:

Scheduled inspections and maintenance are vital to continued operation of all pressure control valves and systems. Parts are subject to wear and tear and must be replaced as necessary, depending on the intensity of service conditions.

Warning:

To avoid personal injury or damage to the process system, disconnect operating lines providing air pressure, control signals or electrical power to the actuator. Ensure the actuator cannot suddenly open or close.

Isolate the valve from the system by using bypass valves or by shutting off the process entirely. Relieve any pressure contained on both sides of the valve and drain the process media.

Vent the power actuator, relieve actuator spring pressure and use proper lock-out methods during all maintenance procedures.

Replacing Packing:

When conducting packing maintenance, the actuator must be removed from the valve. It is also recommended that the valve be removed from the pipeline to allow for adjustment of the valve closed position.

If the packing is new and tight on the shaft, and if leakage cannot be stopped by tightening the packing nuts, it is likely that the shaft has become worn or nicked.

If the leakage originates from the outside diameter of the packing, nicks or scratches may have damaged the packing box wall. Inspect the shaft and packing box during the following procedures.

If it is not possible to control leakage around the valve shaft by tightening packing flange bolts, the packing may need to be replaced.

Split-Ring Packing:

Before beginning any maintenance, it is important to isolate the control valve and release all pressure contained in the valve body and the actuator.

Note: exercise caution during disassembly. Nicks and scratches will affect the ability to seal the valve in the future.

1. Remove packing flange nuts (key 3) and lift the packing follower (key 15) from the packing box.
2. With a formed wire hook remove the packing rings.
3. Clean the packing box, all metal parts, and complete the required maintenance.
4. Expand the split ring of the new packing to allow it to pass over the valve shaft. Stagger the connecting lines, then slide the rings in to the packing box.
5. Tighten the packing flange nuts until they are finger tight. Test under flow conditions. Continue tightening the nuts until all leakage has stopped.

Solid Ring Packing:

Isolate the control valve. Release all pressure contained in the valve body, and the actuator. Prior to disassembly, note the orientation of the actuator and lever in relation to the valve body.

Use caution when removing the actuator lever, using a wheel-puller if necessary. If the actuator lever is forced off the valve shaft the ball could move from the centered position, damaging the V-Ball, seal and valve body.

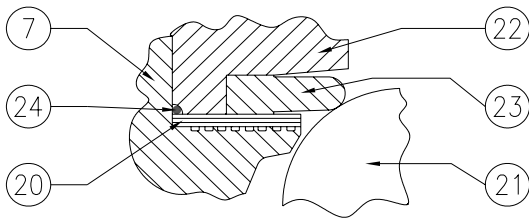

Figure 1. Section view of Heavy Duty Composition (TCM) Ball Seal

1. Remove the actuator cover.
2. Remove the lever.
3. Disconnect the actuator and body cap screws (key 4) and hex nut if used (key 5)
4. Remove the packing flange nuts (key 3), packing flange, if used, and packing follower.
5. Remove the packing rings (key 6) with a formed wire hook. To remove the TFE V-ring packing, the wire hook should have a sharp end to allow you to pierce the packing for removal.
6. Clean the packing box, all metal parts and complete all required maintenance.
7. Replacing single packing
 - 7.1 Replace the packing box ring (key 18).
 - 7.2 Next, replace the packing rings (key 6).
8. Replacing double packing arrangements
 - 8.1 Replace the packing box ring (key 18).
 - 8.2 Replace one half of the total number of packing rings (key 6).

- 8.3 Install the packing washer, if used.
- 8.4 Replace the lantern ring and the remaining packing rings.
- 8.5 If used, replace the packing
- 8.6 Install the packing follower (key 15)
- 8.7 Replace the packing flange, if used
- 8.8 Replace and tighten the packing flange nuts until they are finger tight.
9. Reconnect the actuator following the previously noted orientation.
10. Replace the cap screws (key 4) and hex nuts (key 5) using the torques from table 6.
11. Follow the actuator instruction manual to complete the actuator assembly and to set the travel adjustment.
12. After the valve is placed in service, the packing flange nuts may require retightening to prevent leakage.

Ball Seal or Flow Ring Maintenance:

Caution must be used when working near the V-ball. The V-Ball closes with a shearing, cutting motion and can cause personal injury or property damage if objects become caught in a closing valve. Be sure to keep the path of the V-notch valve clear while stroking the valve.

Disassembly:

1. Isolate the valve from the line.
 - 1.1 It is necessary for the removed valve to be positioned so that the seal ring or flow ring is pointed upward
 - 1.2 Ensure that V-ball (key 21) is in the open position.
2. Remove the cap screws that secure the seal protector ring in place.
3. Carefully remove the ring from the body, ensuring that the surface of the ball is not nicked or scraped.
4. Remove the O-ring (key 24), if used.

Ball Seal or Flow Ring Maintenance Cont'd:

5. Mark the position of the ball seal and the valve body, so that it can be returned to its original position when it is reinstalled.
6. Carefully remove:
 - 6.1 The bi-directional metal or TCM ball seal (key 23)
 - 6.2 The back-up ring
 - 6.3 Shim seals
7. Clean all parts and inspect for damage.

Installation of Metal, Bi-directional Metal or Heavy-Duty Composition (TCM) Ball Seal.

1. Inspect the sealing surface of the valve body for nicks and scratches that will prevent the shims from sealing.
2. Turn the V-ball to the closed position and install the appropriate number of shims (Key 20) from table 3. For the bi-directional metal ball seal, use a 1/1000-inch or 1/4 mm thick test shim. A piece of paper would be a suitable alternative. Place the test shim across the ball face.
3. Check for nicks and scratches on the ball seal, sealing surface, and backup ring. Install the ball seal and the backup ring on top of the shim seals. If damage was detected on any of the components, the damage should be turned away from the V-ball. Install the bi-directional ball seals, to ensure proper orientation, use the marks made in step number 5 of the removal.
4. Metal and TCM ball seals:
 - 4.1 Install seal protector ring (key 22) on the ball seal and shim seals (key 23 and key 20).
 - 4.2 Secure the seal protector ring and the ball seal to the valve body by threading and tightening the capscrews. To obtain the closest ball deflection to zero, add and remove shim seals (key 20).

- 4.3 Zero ball seal deflection is when a .005 inch or 0.13 mm shim causes the seal to be broken between the v-notched ball and the ball seal. The parts must be secure or an inaccurate zero will result.
5. Bi directional metal ball seals:
 - 5.1 Install seal protector ring (key 22) on the ball seal and shim seals (key 24 and key 20).
 - 5.2 Secure the seal protector ring, ball seal and shims (key 24 and 20) by threading and tightening the capscrews (key 19).
 - 5.3 Zero ball seal deflection can be tested by removing the 1/1000 of an inch or .025 mm thick test shim from under the ball seal. If this is possible, remove the seal protector ring, the ball seal, and the back-up ring.
 - 5.4 To check the zero deflection, remove one shim, and assemble the parts. Attempt to remove one 1/1000 inch or 0.025mm shim. If the shim is neither to tight or to loose, then zero deflection is obtained.
6. Once zero deflection is obtained remove:
 - 6.1 The seal protector ring
 - 6.2 The ball seal
 - 6.3 The back up ring (if the bi-directional metal seal is used)
 - 6.4 The number of seals indicated in table 4.
 - 6.5 For the bi-directional metal ball seal leave at least one shim seal in the body.
7. Install the ball seal and the backup ring, if one is used.
8. For metal ball seals, install one shim seal (key 20) on top of the metal ball seal.
9. Install O-ring (key 24), if used, into the body.
10. Ensure that the ball seal is centered on the V-ball. For the bi-directional ball match orientation marks that were made in step 5 of the removal section.
11. Install the seal protector ring (key 22) and screw the cap screws and washers, (if used) to secure the body.

Installation of Flow Ring:

1. Ensure that the V-ball (Key 21) is in the closed position. Replace the shim seals in the body Table #3
2. Install the O-ring (Key 24) in the body and position the flow ring to ensure that it is centered and that it does not touch the v-ball.
3. Install the washers that hold the seal protector and twist on the cap screws.
4. Check the minimum clearance of the flow ring and the V-ball from table 5. Measure the existing clearance and adjust to obtain the minimum clearance by adding and removing shims.

Drive Shaft and V-Ball:

Disassembly:

Caution:

Use care when removing the actuator lever, using a wheel-puller if necessary. If the actuator lever is forced off the valve shaft the ball could move from the centered position, damaging the V-Ball, seal and valve body.

Before disassembly, note the orientation of the actuator in relation to the body and note the orientation of the lever in relation to the valve body.

1. Remove the actuator cover.
2. Remove the lever.

When the actuator is removed from the valve body, the ball/shaft assembly may rotate and cause personal injury or damage to equipment. Prevent rotation by turning the V-Ball to a stable position in the body.

3. Detach the valve from the line. It is necessary for the removed valve to be positioned so that the seal ring or flow ring is pointed upward
4. Unscrew the cap screws (key 19) that hold the seal protector ring in place (key 22).

5. Carefully remove the ring from the body ensuring that the surface of the ball is not nicked or scraped
6. Remove the O-ring (key 24).
7. Remove the ball seal (key 23) from the ball seal constructions.
8. Lift the shim seals (key 20).
9. Clean all parts and inspect for damage.
10. Remove packing flange nuts (key 3) and lift the packing flange and follower (key 15) from the packing box.
11. With a formed wire hook, remove the packing rings.
12. Clean the packing box and all metal parts complete all required maintenance.
13. Locate and remove the groove pin (key 10).
14. Unscrew the guidepost retaining nuts (key 14) or the retainer, depending on valve body size.
15. Support the V-ball securely and remove the guidepost, not allowing the guidepost to scratch the seal.
16. Remove:
 - 16.1 Guide post retainer (key 25)
 - 16.2 Guide post (key 13)
 - 16.3 Gasket (key 12)
 - 16.4 Spring retainer washer (for sizes 3 inch and larger).
17. The drive shaft is pushed into the body from the bonnet. The drive shaft is aligned with the guidepost bushing. (key 11)
18. Find the groove pin hole, noting that the V-Ball has a raised flat surface on one side. To remove the groove pin, place a punch on the side of the ball opposite the raised flat surface and drive the out pin (Key 10). See Figure 12.
19. Slip the drive shaft through the body out the guidepost end. Remove the thrust washer.
20. Carefully remove the ball from the body ensuring that the surface of the ball is not nicked or scraped.

To remove the bearings (Keys 8 and 11) see figure 5 for replacing the bearings. Refer to the bearing replacement procedure. When a new body (Key 7) and drive shaft bearing (Key 8) or V-Ball (Key 21) and guide post bearing (Key 11) is ordered, the bearing will be pressed in at the factory.

Assembly:

1. Follow the instructions on the bushing replacement from this manual.
2. Carefully insert the V-ball in the body ensuring the surface of the ball is not nicked or scraped. Provide secure support for the V-ball.

While installing the drive shaft, hold the thrust washer(s) (Key 9) between the drive shaft bearing (Key 8) and the V-Ball (Key 21).

3. Slip the drive shaft into the guidepost end through body.
4. Match the index mark on the shaft with index mark on the V-ball.
5. Gasket installation
 - 5.1 2 In Body – Slip the gasket (key 12) over the guide post (key 13) and hold the wave spring, if used, between the ball and the body. Insert the guidepost assembly into the body, wave spring, and ball valve.
 - 5.3 3, thru 8 inch bodies - Slide both the gasket (key 12) and the spring retainer washer (if required) over the guide post (key 13) and hold the wave spring, if used, between the V-ball and the body. Insert the guidepost assembly into the body, wave spring, and ball valve.
6. Insert the retainer for the guidepost and secure with retainer nuts; for body sizes 2-through 8 inch. Tighten nuts to the recommended torque from table 6.
7. Insert groove pin (key 10) to lock the drive shaft and V-ball connection. The pin should enter from the large hole and go towards the smaller diameter hole. The pin should be flush with both ends.
8. Replace the packing box ring (key 18) and install the new packing (key 6).
9. Install the packing follower (key 15) and replace the packing flange if used. Replace and tighten the packing flange nuts until they are finger tight. When under actual flow conditions the nuts will need additional tightening to control leaking.

10. Following the instructions under ‘Ball Seal or Flow Ring Maintenance’, replace the ball seal or flow ring.
11. Reconnect the actuator using the actuator orientation that was noted previously. The cap screws (key 4) and hex nuts (key 5) should be torqued to the values listed in table 6.
12. Install the lever using orientation that was noted previously and the identifying marks from figure 3.
13. Use the appropriate actuator instructions for remaining mounting instructions and the travel adjustment.

Bushing Replacement

CVS does not recommend replacing bushings in the field. The procedure is difficult and may cause permanent damage to the V-ball. If replacement of the bushing in the field is necessary, follow the instructions that follow and the dimensions in figure 5.

Note:

Do not heat the valve in an attempt to ease the replacement procedure of the body bushing. Heating the valve will cause the plastic-lined material to release fluorine gas, which is extremely hazardous, causing; poisoning, suffocation, and burns.

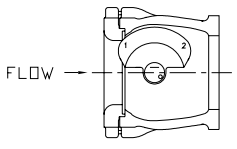
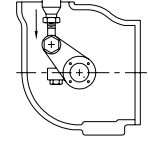
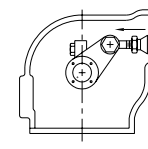
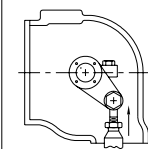
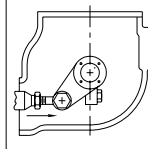
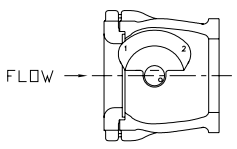
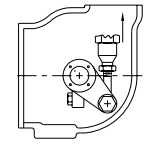
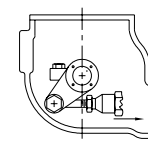
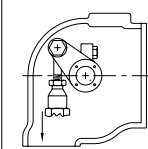
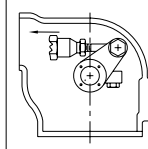
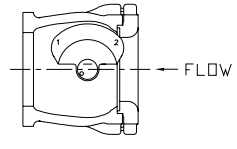
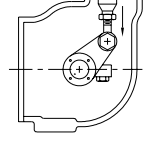
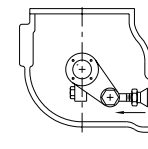
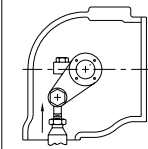
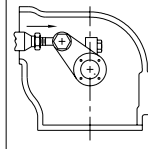
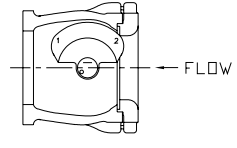
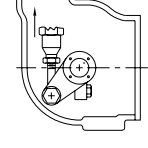
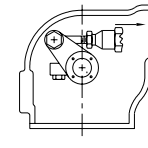
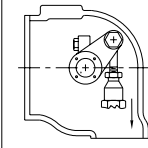
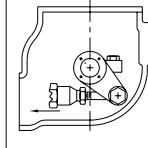

Figure 2. V-Ball showing Groove Pin Hole

ACTUATOR		VALVE OPEN	ACTUATOR POSITION			
MOUNTING	STYLE		1	2	3	4
RIGHT HANDED	STYLE A (PDTC)					
	STYLE B (PDTO)					
LEFT HANDED	STYLE C (PDTC)					
	STYLE D (PDTO)					

NOTES: 1. ARROW ON LEVER INDICATES DIRECTION OF ACTUATOR THRUST TO CLOSE VALVE.
2. PDTC-PUSH DOWN TO CLOSE; PDTO-PUSH DOWN TO OPEN
3. RIGHT-HAND MOUNTING CONTROLS WITH V NOTCH NO. 1
LEFT-HAND MOUNTING CONTROLS WITH V NOTCH NO. 2
4. FOR 60-DEG OPERATION WITH PUSH DOWN-TO-CLOSE ACTION

(EXTENDING ACTUATOR ROD CLOSING VALVE), ROTATE ACTUATOR LEVER CLOCKWISE SO THAT LEVER INDEX MARK IS OFFSET 1 SPLINE TOOTH FROM VALVE SHAFT INDEX MARK FOR 1/2" THROUGH 3/4" (12.7 mm THROUGH 19.1 mm) VALVE SHAFTS AND 2 SPLINE TEETH FROM VALVE SHAFT INDEX MARK FOR 7/8" (22.2 mm) AND LARGER VALVE SHAFTS.

Figure 3. Index Marks for Actuator Lever Orientation

CONSTRUCTION	BODY SIZE, INCHES	A ⁽¹⁾		B ⁽¹⁾		MM					
		ANSI FLANGES									
		CLASS 150		CLASS 300		CLASS 600					
		In.	mm	In.	mm	In.	mm	In.	mm	In.	mm
STANDARD	2	4.88	124	2.19	56	8.25	206	8.50	216	9.25	235
	3	6.50	165	3.00	76	10.12	270	11.12	282	11.50	292
	4	7.62	194	3.12	79	11.44	291	12.12	308	13.62	346
	6	9.00	229	4.00	102	13.62	346	14.38	365	16.50	419
	8	9.56	243	5.75	146	13.62	346	15.38	391	17.12	435

1. DOES NOT INCLUDE GASKETS

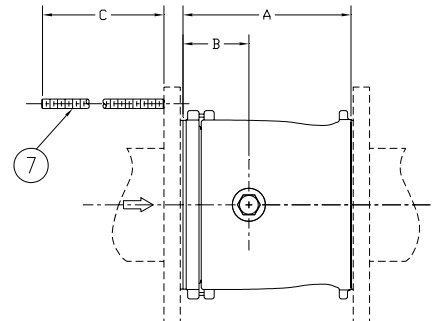

Figure 4. Required clearances for installation of design CVS V-100 Ball Valve Body

BODY SIZE, IN	BODY BUSHING											GUIDE POST BUSHING								
	A				B RAMS 1 & 2		C		D		E (min.)		A				B RAMS 3 & 4		E (min.)	
	RAM 1		RAM 2										RAM 3		RAM 4					
	mm	In.	mm	In.	mm	In.	mm	In.	mm	In.	mm	In.	mm	In.	mm	In.	mm	In.	mm	In.
2	15.37	.060	25.40	1.000	12.70	.500	19.05	.750	80.84	3.183	114	4.5	19.81	.780	29.92	1.06	15.88	.625	25	1.0
	15.11	.595	24.89	.980	12.45	.490	18.80	.740	80.79	3.181			19.56	.770			15.62	.615		
3	21.72	.855	31.75	1.250	19.05	.750	26.44	1.041	117.17	4.613	146	5.75	29.46	1.160	36.51	1.44	23.75	.935	38	1.5
	21.46	.845	31.24	1.230	18.80	.740	26.19	1.031	117.09	4.610			29.21	1.150			23.50	.925		
4	24.89	.980	34.93	1.375	22.23	.875	29.59	1.165	141.81	5.583	152	6	32.51	1.280	39.69	1.56	26.92	1.060	38	1.5
	24.64	.970	34.42	1.355	21.97	.865	29.34	1.155	141.73	5.580			32.26	1.270			26.67	1.050		
6	28.07	1.105	41.28	1.625	1.000	1.000	34.37	1.353	190.12	7.485	165	6.5	37.34	1.470	44.45	1.75	31.75	1.250	51	2.0
	27.81	1.095	48.77	1.605	.990	.990	34.11	1.343	190.02	7.481			37.08	1.460			31.50	1.240		
8	34.42	1.355	49.23	1.938	31.75	1.250	40.72	1.603	233.86	9.207	191	7.5	43.69	1.720	50.8	2	38.10	1.500	51	2.0
	34.16	1.345	48.72	1.918	31.50	1.240	40.46	1.593	233.76	9.203			43.43	1.710			37.85	1.490		

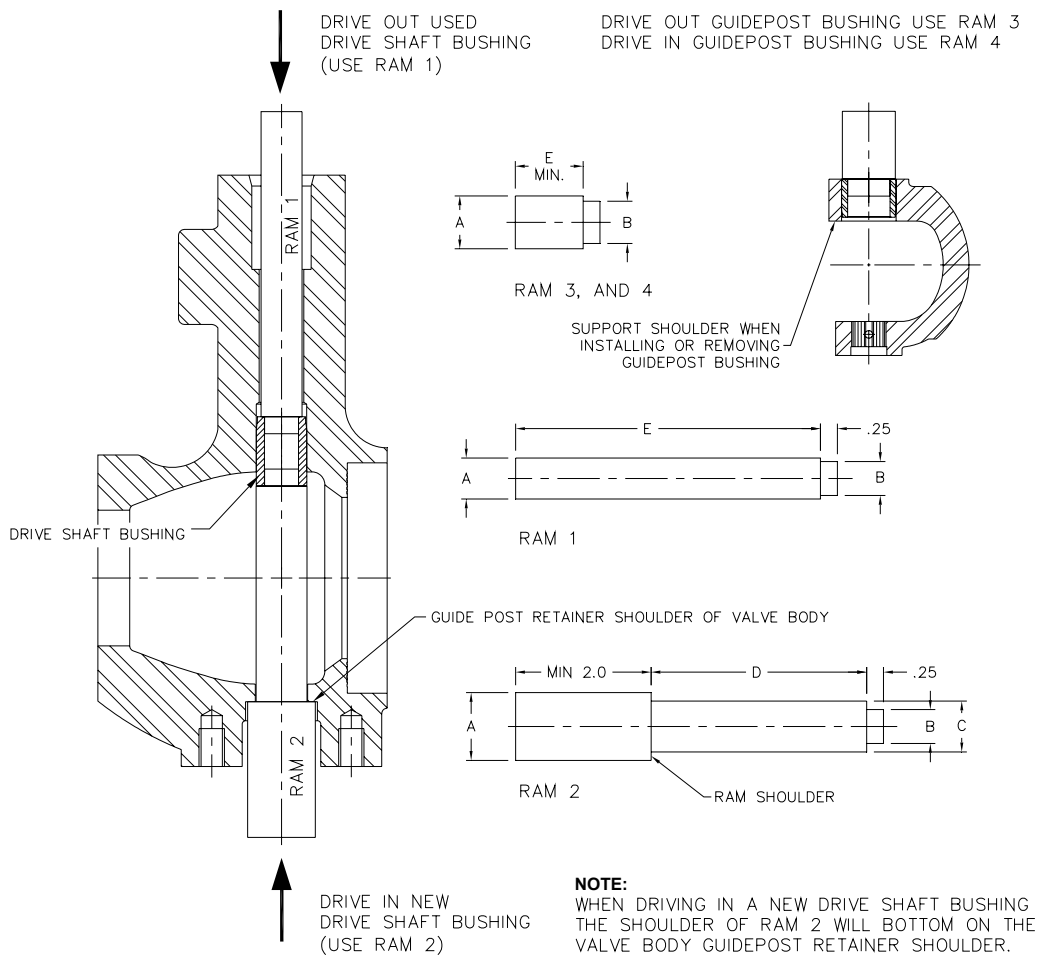

Figure 5. Ram Dimensions for replacing Bearings

Body Bushings

1. Follow the instructions for disassembly in the “Drive Shaft and V-Ball Disassembly” section of this manual.
2. From figure 5 select the proper size ram and insert it in the body. This will allow you to drive out the bushing with a hydraulic press.
3. Apply a suitable lubricant to the outside diameter of the bushing. CVS recommends the lubricant Moly-Kote.
4. To install the bushing:
 - 4.1 Place the bushing in the bushing bore
 - 4.2 Ensure that the bushing lead is in the chamber is turned toward the bushing bore
 - 4.3 2 thru 8 inch –drive the bushings into the body using ram 2. The bushing is in the suitable position when larger shoulder on the ram contacts the valve body.
5. Follow the assembly instruction in the Drive shaft V-Ball section of this manual.

Guide Post Bushing

- 1 Follow the instruction for the removal of the V-Ball in the “Drive Shaft and V-Ball disassembly” section of this manual.
2. Ensuring that the ball is properly supported, insert the proper ram size 1. Without proper support, the ball can be permanently damaged.
3. Remove the old bushing using a hydraulic press.
 4. Apply a suitable lubricant to the outside diameter of the bushing. CVS recommends the lubricant Moly-Kote.
5. To install the bushing
 - 5.1 Place the bushing in the bushing bore.
 - 5.2 Ensure that the bushing lead in chamber is turned toward the bushing bore.
6. The bushing can be installed with a ram that is larger than the outside diameter than of the bushing. Using this type of ram will ensure that the bushing is inserted correctly. Bushings that are improperly installed may cause equipment damage.
7. Support the ball as indicated in figure 5. Push the new bushing in flush with the ball ear.
8. Follow the ‘Drive Shaft and V-Ball Maintenance’ section of this manual to the valve.

Parts Ordering

Each V-Ball Valve Body assembly is assigned a serial number, which can be found on the nameplate. Refer to this serial number when contacting your CVS Controls representative. When ordering replacement parts, specify the serial number, key number, and part description, from the following Parts Lists.

Repair Kits

Recommended spare parts for TCM or stainless steel ball seal constructions are available as complete kits. Gasket material is composition for temperatures up to 450°F (232°C). Packing is PTFE and carbon filled PTFE in single arrangements for standard packing box depth. Since most original shim seals can be re-used during repair, kits include fewer shim seals than are originally furnished.

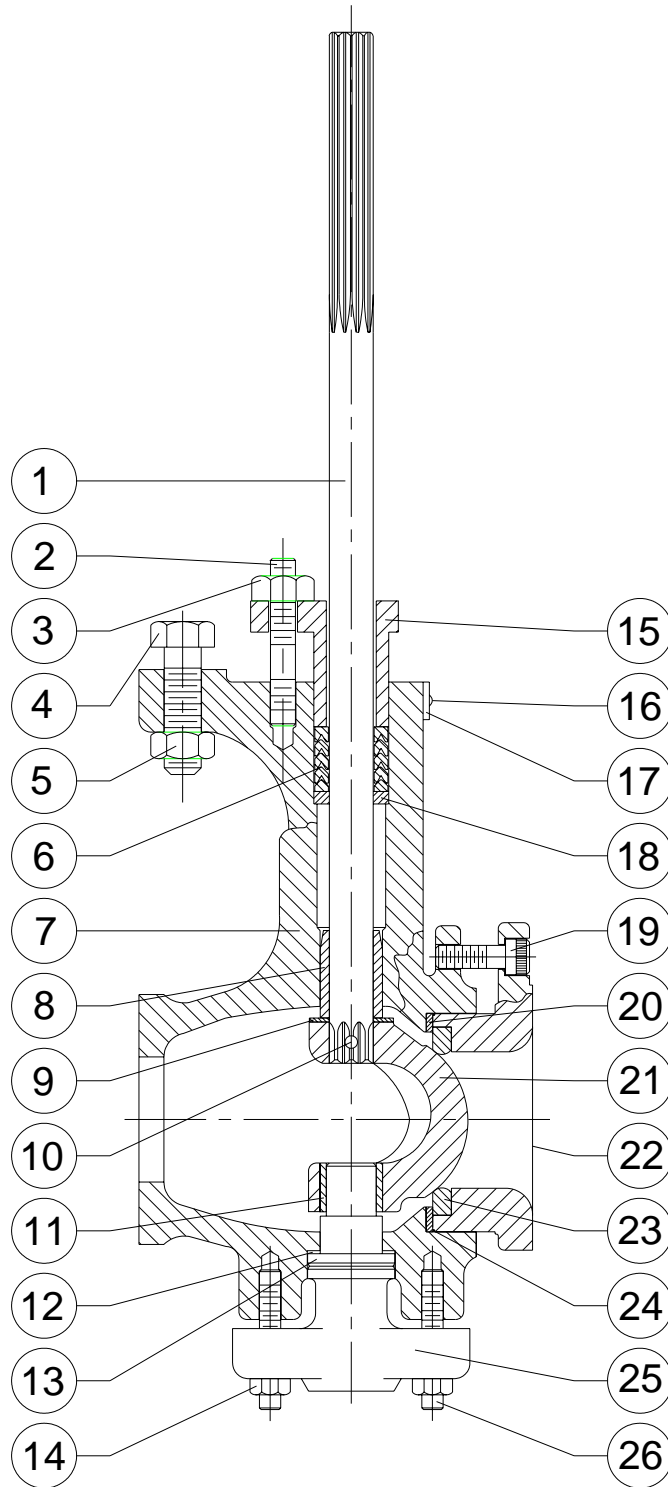

Figure 12. Typical Cross Section of 2-8 inch Design CVS V-100 Ball Valve

Parts List

Key No.	Description		Part Number	
1	Drive Shaft	2-inch, shaft diameter 1/2" (12.7 mm)	CVS33A2543 X012	
		3-inch, shaft diameter 3/4" (19.1 mm)	CVS33A2561 X012	
		4-inch, shaft diameter 7/8" (22.2 mm)	CVS33A2597 X012	
		6-inch, shaft diameter 1" (25.4 mm)	CVS34A6877 X012	
		8-inch, shaft diameter 1-1/4" (31.8 mm)	CVS33A2641 X012	
2	Packing Flange Stud (2 req'd)	B7M Steel	2" and 3"	CVS1E9441 31032
			4" and 6"	CVS12A8835 X012
			8"	CVS12A8950 X012
		B8M Strain Hardened SST	2" and 3"	CVS1E9441 35222
			4" and 6"	CVS12A8835 X022
			8"	CVS12A8950 X022
3	Packing Flange Nut (2 req'd)	B7M SS Steel Flange Studs	2" thru 4"	CVS1E9440 24112
			6"	CVS1A3753 24112
			8"	CVS1A3412 24112
		B8M Steel Flange Studs	2" thru 4"	CVS1E9440 35252
			6"	CVS1A3753 35252
			8"	CVS1A3412 35252
4	Cap Screw, pl steel	2" (2 req'd)	CVS1A3409 24052	
		3" (2 req'd)	CVS1A3409 24052	
		4" and 6" (4 req'd)	CVS1A3409 24052	
		8" (4 req'd)	CVS1A5444 24052	
5	Hex Nut, pl steel (2 req'd)		CVS1A3772 24112	
6	Single Arrangements	PTFE / Composition Ring	2"	CVS12A9016 X012
			3"	CVS12A8995 X012
			4"	CVS13A2604 X012
			6"	CVS12A8832 X012
			8"	CVS12A8951 X012
		Grafoil	2"	CVS12A9134 X012
			3"	CVS12A9136 X012
			4"	CVS14A4920 X012
			6"	CVS12A9137 X012
			8"	CVS12A9138 X012
7	Valve Body		See Following Table	
8	Drive Shaft Bearing		See Following Table	
9	Thrust Washer	316 SST	2"	CVS13A2518 X012
			3" (2 req'd)	CVS13A2570 X012
			4" (2 req'd)	CVS13A2590 X012
			6" (2 req'd)	CVS13A2624 X012
			8" (2 req'd)	CVS13A2651 X012

Parts List

Key No.	Description		Part Number	
10	Groove Pin, 316 SST		2"	CVS18A6134 X012
			3"	CVS18A6135 X012
			4"	CVS18A6136 X012
			6"	CVS18A6137 X012
			8"	CVS18A6138 X012
11	Guide Post Bushing		See Following Table	
12	Gasket	Garlock 2900	2"	CVS13A2521 X012
			3"	CVS13A2573 X012
			4"	CVS13A2593 X012
			6"	CVS13A2627 X012
			8"	CVS13A2654 X012
13	Guide Post	316 SS	2"	CVS13A2544 X012
			3"	CVS13A2562 X012
			4"	CVS13A2582 X012
			6"	CVS13A2616 X012
			8"	CVS13A2642 X012
14	Retainer Nut		See Following Table	
15	Packing Follower, CF8M (316 SST)		2"	CVS16A6078 X012
			3"	CVS26A6080 X012
			4"	CVS27A4113 X012
			6"	CVS26A6077 X012
			8"	CVS26A6081 X012
16	Drive Screw, SST (2 req'd)		CVS1A3682 28982	
17	Name Plate, SST		CVS13A2599 X012	
18	Packing Box Ring	316 SST	2"	CVS12A9020 X012
			3"	CVS12A8984 X012
			4"	CVS13A2607 X012
			6"	CVS12A8823 X012
			8"	CVS12A8956 X012
19	Screw, pl steel (2 req'd)		2"	CVS1B4638 X0012
			3"	CVS1V1542 38982
			4"	CVS1U7648 X0012
			6" and 8"	CVS1A5607 24052

Parts List

Key No.	Description			Part Number
20	Shim Seal, 316 SST	TCM Ball Seal	2"	CVS13A2545 X022
			3"	CVS13A2564 X022
			4"	CVS13A2584 X022
			6"	CVS13A2618 X022
			8"	CVS13A2644 X022
		Metal Ball Seal	2"	CVS14A6559 X012
			3"	CVS14A6560 X012
			4"	CVS14A6561 X012
			6"	CVS14A6154 X012
			8"	CVS14A6155 X012
21	V- Ball	2"	CVS23A2540 X0A2	
		3"	CVS33A2557 X0A2	
		4"	CVS33A2579 X0A2	
		6"	CVS33A2611 X0A2	
		8"	CVS4362637 X0A2	
22	Seal Protector Ring			See Following Table
23	Ball Seal	TCM	2"	CVS13A2546 X012
			3"	CVS13A2565 X012
			4"	CVS13A2585 X012
			6"	CVS13A2619 X012
			8"	CVS13A2645 X012
		Metal, 316 SST	2"	CVS14A1758 X012
			3"	CVS14A1759 X012
			4"	CVS14A1760 X012
			6"	CVS14A1761 X012
			8"	CVS13A1762 X012
24	O-Ring, PTFE	2"	CVS14A1345 X012	
		3"	CVS14A1346 X012	
		4"	CVS14A1347 X012	
		6"	CVS14A1348 X012	
		8"	CVS14A1349 X012	
25	Guide Post Retainer	CF8M Valve Body	2"	CVS13A2542 X022
			3"	CVS13A2559 X022
			4"	CVS13A2581 X022
			6"	CVS13A2613 X022
			8"	CVS23A2639 X022
26	Retainer Stud			See Following Table
*27	Pipe Plug, 316 SST (Not Shown)			CVS 1A7675 35072
*28	Line Studs (Contact CVS Sales Representative)			-----

Parts List

Key No.	Description	Part Number	
*29	Cap Screw, pl steel (2 req'd)	6"	CVS1F9603 24052
		8"	CVS1D7704 24052
*30	Washer or Stop Nut, pl steel (2 req'd)	6" (Washer)	CVS1B8659 28982
		8" (Stop Nut)	CVS1V1362 28982
*31	Nameplate (Not Shown)	CVS13B2599 X012	
*32	Wire (Not Shown) (For valve purchased without actuator)	CVS16A3188 X012	
*33	Gasket, 316 SST/Graphite	6"	CVS1U1805 X0012
		8"	CVS1U1804 X0022
*_-Not Shown			

Key 7, Valve Body

BODY SIZE, INCHES	CF8M
	STD. PACKING BOX
2	CVS43A2538 X0B2
3	CVS43A2555 X0B2
4	CVS43A2577 X0B2
6	CVS43A2609 X0B2
8	CVS43A2635 X0B2

Key 8, Main Shaft Bushing

BODY SIZE, Inches	316 SS TFE	440C SS	Alloy 6 (CoCr-A)	SILVER PLATED CoCr-A
2	CVS13A2519 X022	CVS17A8654 X012	CVS17A8655 X012	CVS17A8656 X012
3	CVS13A2571 X022	CVS18A6416 X012	CVS18A6147 X012	CVS18A6148 X012
4	CVS13A2591 X032	CVS18A6149 X012	CVS18A6150 X012	CVS18A6151 X012
6	CVS13A2625 X022	CVS18A6152 X012	CVS18A6153 X012	CVS18A6154 X012
8	CVS13A2652 X022	CVS18A6155 X012	CVS18A6156 X012	CVS18A6157 X012

Key 11, Guide Post Bushing

BODY SIZE, Inches	316 SS TFE	440C SS	Alloy 6 (CoCr-A)	SILVER PLATED CoCr-A
2	CVS13A2551 X022	CVS14A6653 X012	CVS15A0427 X012	CVS15A0424 X012
3	CVS13A2572 X022	CVS15A0435 X012	CVS15A0437 X012	CVS15A0436 X012
4	CVS13A2592 X032	CVS15A0441 X012	CVS15A0443 X012	CVS15A0442 X012
6	CVS13A2626 X022	CVS15A0445 X012	CVS14A7278 X012	CVS14A8579 X012
8	CVS13A2653 X022	CVS15A0449 X012	CVS15A0451 X012	CVS15A0450 X012

Parts List

Key 14 & 26, Retainer Nut and Retainer Stud

BODY SIZE, INCHES	B8M STAINLESS STEEL	
	Nut (Key 14)	Stud (Key 26)
2	CVS1A3772 24072	CVS1F4380 31012
3	CVS1A3374 24072	CVS1V8441 X0012
4	CVS1A3772 24072	CVS1A4207 31012
6	CVS1C3306 24072	CVS1H2597 X0012
8	CVS1A3520 24072	CVS1B9588 31012

Key 22, Seal Protector Ring

BODY SIZE, INCHES	TCM BALL SEAL	METAL BALL SEAL
	316 Stainless Steel	316 Stainless Steel
2	CVS23A2549 X022	CVS24A1747 X022
3	CVS23A2569 X022	CVS24A1748 X022
4	CVS23A2589 X022	CVS24A1749 X022
6	CVS23A2623 X022	CVS24A1750 X022
8	CVS23A2649 X022	CVS24A1751 X022

CVS

Controls Ltd.

Head Office

3900 – 101 Street
Edmonton, Alberta, Canada T6E 0A5
Office: (780) 437-3055
Fax: (780) 436-5461

Calgary Sales Office

205, 2323 – 32 Avenue NE
Calgary, Alberta, Canada T2E 6Z3
Office: (403) 250-1416
Fax: (403) 291-9487

Website: www.cvs-controls.com E-Mail: info@cvs-controls.com

*Printed in Canada
Rev 1, May 06*